

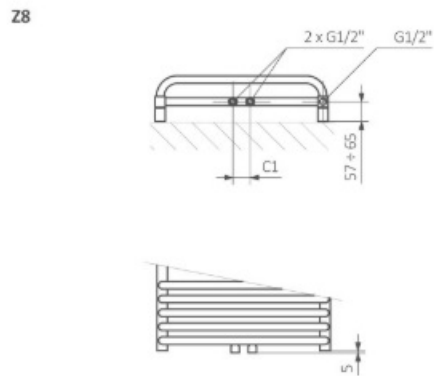

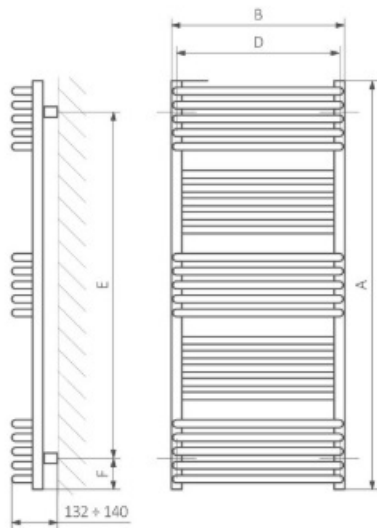

Sběratel a potrubí



A ↓ [mm]	B ↔ [mm]	C1 ? [mm]	C2 ? [mm]	C3 ? [mm]	C5 ? [mm]	75/65/20°C [W]	55/45/20°C [W]	 [W]	D [mm]	E [mm]	F [mm]	 [dm³]	 [kg]	Kód výrobku
powder paint														
780	500	50	470	740	500	392	211	400	470	600	90	3.34	6.99	WGPAL078050
780	600	50	570	740	500	471	254	400	570	600	90	3.79	7.99	WGPAL078060
1180	500	50	470	1140	500	638	342	600	470	1000	90	5.39	11.28	WGPAL118050
1180	600	50	570	1140	500	766	411	800	570	1000	90	6.14	12.95	WGPAL118060
1580	500	50	470	1540	500	883	473	800	470	1400	90	7.44	15.57	WGPAL158050
1580	600	50	570	1540	500	1061	568	1000	570	1400	90	8.49	17.91	WGPAL158060
Galvanic coating														
780	500	50	470	740	500	275	140	300	470	600	90	3.34	6.72	WGPAL078050
780	600	50	570	740	500	330	169	300	570	600	90	3.79	7.68	WGPAL078060
1180	500	50	470	1140	500	447	228	400	470	1000	90	5.39	10.84	WGPAL118050
1180	600	50	570	1140	500	537	274	600	570	1000	90	6.14	12.44	WGPAL118060
1580	500	50	470	1540	500	619	316	600	470	1400	90	7.44	14.96	WGPAL158050
1580	600	50	570	1540	500	743	379	800	570	1400	90	8.49	17.20	WGPAL158060

# Pola



Barva je zahrnuta v ceně

Realizační lhůta: 23 dnů

Připojení:



Doporučujeme pro připojení ZX, Z1 i Z8:



Integrovaná sada termostatická, chrom  
WRZT5G1-CR: 112 EUR  
WRZT5G2-CR: 112 EUR  
Sady venku: viz s. 180.



Sada krycí integrovaná, chrom  
TGPCR002: 33 EUR  
Sada krycí viz s. 203.

Elektrické radiátory – viz strana 114.



Max. provozní tlak: 1000 kPa Maximální provozní teplota: 95°C

Výška [mm]	Šíře [mm]	Průzková barva			Galvanický povrch Chrom			Barvy RAL a speciální barvy Cena bez DPH [EUR]	Chrom Cena bez DPH [EUR]	Kód výrobku	Kód konfigur. info s. 232. ▶
		75 65/20°C [W]	55 45/20°C [W]	400 [W]	75 65/20°C [W]	55 45/20°C [W]	400 [W]				
780	500	392	211	400	274	140	300	124	384	WGPAL078050	VLOŽTE KÓD
780	600	471	254	400	330	168	300	132	422	WGPAL078060	VLOŽTE KÓD
1180	500	638	342	600	447	228	400	163	485	WGPAL118050	VLOŽTE KÓD
1180	600	766	411	800	536	273	600	177	522	WGPAL118060	VLOŽTE KÓD
1580	500	883	473	800	618	315	600	193	685	WGPAL158050	VLOŽTE KÓD
1580	600	1061	568	1000	743	379	800	223	735	WGPAL158060	VLOŽTE KÓD

# Pola One



Barva je zahrnuta v ceně

Radiátor se zabudovanou topnou tyčí One.  
Realizační lhůta: 23 dnů

Připojení:



Doporučujeme pro připojení S1 i S8:



Integrovaná sada termostatická s ponornou trubicí, chrom  
WRZT5G5-CR: 117 EUR  
WRZT5G6-CR: 117 EUR  
Sady venku: viz s. 180.



Sada krycí integrovaná, chrom  
TGPCR002: 33 EUR  
Sada krycí viz s. 203.

Elektrické radiátory – viz strana 110.



Max. provozní tlak: 1000 kPa Maximální provozní teplota: 82°C

Výška [mm]	Šíře [mm]	Průzková barva			Galvanický povrch Chrom			Barvy RAL a speciální barvy Cena bez DPH [EUR]	Chrom Cena bez DPH [EUR]	Kód výrobku	Kód konfigur. info s. 234. ▶
		75 65/20°C [W]	55 45/20°C [W]	400 [W]	75 65/20°C [W]	55 45/20°C [W]	400 [W]				
780	500	392	211	400	274	140	300	203	463	WZPAN078050	VLOŽTE KÓD
780	600	471	254	400	330	168	300	211	501	WZPAN078060	VLOŽTE KÓD
1180	500	638	342	600	447	228	400	242	564	WZPAN118050	VLOŽTE KÓD
1180	600	766	411	800	536	273	600	256	601	WZPAN118060	VLOŽTE KÓD
1580	500	883	473	800	618	315	600	272	764	WZPAN158050	VLOŽTE KÓD
1580	600	1061	568	1000	743	379	800	301	814	WZPAN158060	VLOŽTE KÓD

# Barvy

Uvedené barvy se mohou mírně lišit od skutečných. Pro přesný výběr barev použijte originální vzorník, který je k dispozici u našich obchodních manažerů a prodejních partnerů.



## VZORNÍK BAREV RAL (80% LESKU)

RAL: KÓD:	1000 100	1001 101	1002 102	1003 103	1004 104	1005 105	1006 106	1007 107	1011 111	1012 112	1013 113	1014 114
1015 115	1016 116	1017 117	1018 118	1019 119	1020 120	1021 121	1023 123	1024 124	1027 127	1028 128	1032 132	1033 133
1034 134	1037 137	2000 200	2001 201	2002 202	2003 203	2004 204	2008 208	2009 209	2010 210	2011 211	2012 212	3000 300
3001 301	3002 302	3003 303	3004 304	3005 305	3007 307	3009 309	3011 311	3012 312	3013 313	3014 314	3015 315	3016 316
3017 317	3018 318	3020 320	3022 322	3027 327	3028 328	3031 331	4001 401	4002 402	4003 403	4004 404	4005 405	4006 406
4007 407	4008 408	4009 409	4010 410	5000 500	5001 501	5002 502	5003 503	5004 504	5005 505	5007 507	5008 508	5009 509
5010 510	5011 511	5012 512	5013 513	5014 514	5015 515	5017 517	5018 518	5019 519	5020 520	5021 521	5022 522	5023 523
5024 524	6000 600	6001 601	6002 602	6003 603	6004 604	6005 605	6006 606	6007 607	6008 608	6009 609	6010 610	6011 611
6012 612	6013 613	6014 614	6015 615	6016 616	6017 617	6018 618	6019 619	6020 620	6021 621	6022 622	6024 624	6025 625
6026 626	6027 627	6028 628	6029 629	6032 632	6033 633	6034 634	7000 700	7001 701	7002 702	7003 703	7004 704	7005 705
7006 706	7008 708	7009 709	7010 710	7011 711	7012 712	7013 713	7015 715	7016 716	7021 721	7022 722	7023 723	7024 724
7026 726	7030 730	7031 731	7032 732	7033 733	7034 734	7035 735	7036 736	7037 737	7038 738	7039 739	7040 740	7042 742
7043 743	7044 744	7045 745	7046 746	7047 747	8000 800	8001 801	8002 802	8003 803	8004 804	8007 807	8008 808	8011 811
8012 812	8014 814	8015 815	8016 816	8017 817	8019 819	8022 822	8023 823	8024 824	8025 825	8028 828	9001 901	9002 902
9003 903	9004 904	9006 906	9007 907	9010 910	9011 911	9016 916	9017 917	9018 918				

Některé TERMA barvy RAL jsou na následujících 2 stranách označeny jako MATT (polomat) nebo SOFT (mat) a lze je objednat přímo jako polomatné nebo matné. Všechny ostatní barvy RAL si můžete také objednat jako MATT (50% lesku), nebo SOFT (20-30% lesku) s příplatkem 25%, neboť mají jednu zmatňující vrstvu navíc.

# VZORNÍK SPECIÁLNÍCH BAREV

Název:	Heban (matná metalíza, hrubá struktura)	Black Pepper (matná, hrubá 3D struktura)	Metallic Black (matná metalíza, hrubá struktura)
KÓD:	IHE	CPE	MBC
Black Crocodile New (matná, hrubá 3D struktura)	Soft 9005 (matná, hladká struktura)	Matt 9005 (polomat, hladká struktura)	Gloss 9005 (vysoký lesk, hladká struktura)
BLN	S95	9M5	9P5
Anodic Black (metalíza, hladká struktura)	Magic Pearl (vysoký lesk, hladká struktura)	Sparkling Grey (vysoký lesk, hladká struktura)	Metallic Grey (matná, hrubá struktura)
ABC	MPR	RGY	MGR
Granite (vysoký lesk, hladká struktura)	Modern Grey (matná, hrubá struktura)	Storm Sky (matná, hladká struktura)	Winter Sky (pololesk, hladká struktura)
GRA	DGR	SSK	WSK
Graphite (matná metalíza, hrubá struktura)	Salt & Pepper (matná, hrubá struktura)	Inox (metalíza, hladká struktura)	Diamond Silver (lesklá metalíza, hladká struktura)
GRP	SPP	INO	DIS
Silver Gloss (vysoký lesk, hladká struktura)	Silver Matt (pololesk, hladká struktura)	Metallic Silver (metalíza, hrubá struktura)	Vibrant Brown (metalíza, hrubá struktura)
SPO	SMA	MSI	OVB
Metallic Stone (metalíza, hrubá struktura)	Sparkling Gravel (metalíza, hladká struktura)	Quartz (matná metalíza, hrubá struktura)	Metallic Beige (metalíza, hrubá struktura)
MST	RGR	QUA	MBE
Anodic Brown (metalíza, hladká struktura)	African Bronze (metalíza, hladká struktura)	Noble Brown (matná metalíza, hrubá struktura)	Antique Copper (křídavková, lesklá 3D struktura)
ABN	IAZ	INB	AMI
Copper (měděná metalíza, hladká)	Bright Copper (měděná metalíza, hladká)	Van Gogh (metalíza, hrubá 3D struktura)	Gold Gloss (zlatá metalíza, hladká)
COP	BCO	IVG	GPO

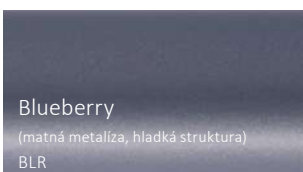
 <p>California Beige (matná metalíza, hrubá struktura) ICB</p>	 <p>Morning Beige (vysoký lesk, hladká struktura) BTS</p>	 <p>Sparkling Cream (matná, hrubá struktura) RCR</p>	 <p>Blush (matná, hrubá struktura) BUH</p>
 <p>Modern Ivory (pololesk, hrubá struktura) DIV</p>	 <p>White Gold (kladivková, lesklá 3D struktura) WGD</p>	 <p>Pergamon (vysoký lesk, hladká struktura) OPE</p>	 <p>Sea Salt (perleťová metalíza, hrubá struktura) FMS</p>
 <p>Sweet Sugar (vysoký lesk, hladká struktura) FSS</p>	 <p>White Cream (pololesk, hladká struktura) WCR</p>	 <p>Soft 9016 (matná, hladká struktura) S96</p>	 <p>White Wall (perleťová metalíza, hrubá struktura) WWL</p>
 <p>Blueberry (matná metalíza, hladká struktura) BLR</p>	 <p>Anodic Sapphire (matná metalíza, hladká struktura) ASP</p>	 <p>Anodic Malachite (matná metalíza, hladká struktura) AMT</p>	 <p>Pastel Blue (matná metalíza, hladká struktura) PBL</p>
 <p>Soft 7047 (matná, hladká struktura) S77</p>	 <p>Lavender (metalíza, hladká struktura) LAV</p>	 <p>Soft 4010 (matná, hladká struktura) S40</p>	 <p>Soft 4006 (matná, hladká struktura) S46</p>
 <p>Soft 3028 (matná, hladká struktura) S38</p>	 <p>Metallic Red (matná metalíza, hrubá struktura) MRE</p>	 <p>Soft Green Apple (matná, hladká struktura) SGA</p>	 <p>Soft 1023 (matná, hladká struktura) S13</p>
 <p>Chrome Effect (imitace chromu, vysoký lesk) CRE</p>			

## Galvanická povrchová úprava

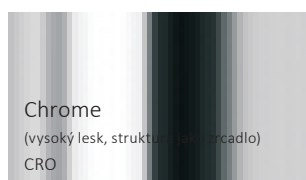

## Raw Copper



Barevná varianta dostupná pouze pro Pajak a Pajak E.  
Vzhledem ke svým vlastnostem může povrch časem změnit barvu, ztmavnout.